

HEAT PRESS JT5B-S-2

EN Start Here

TC 入門指南

BestSub[®]

迷你雙功位烤杯機

 warnings must be followed carefully to avoid bodily injury. 必須嚴格遵守警告事項以免身體受損。

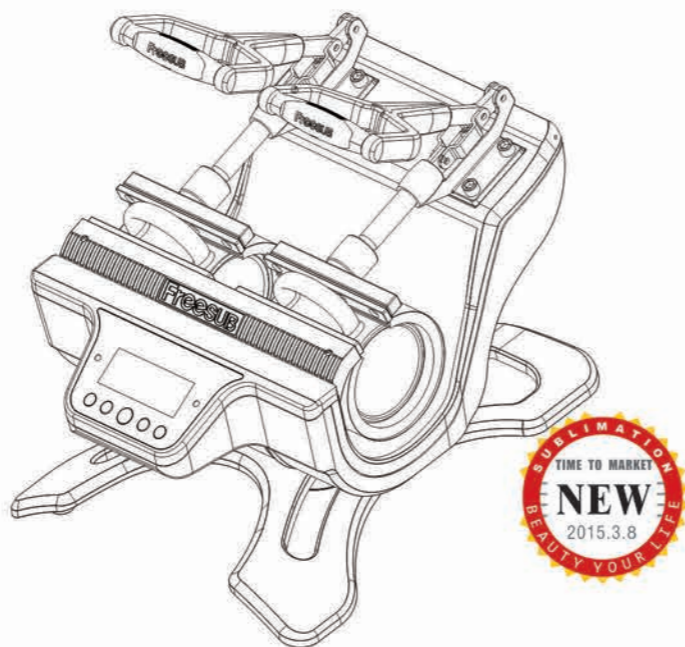

Unpacking 拆裝

Contents may vary by location
內容可能因為地區而有所不同

Please remove the packing foam carefully and keep well for maintenance.
請小心移除設備外包裝泡沫。並保存好該包裝材料，以備維修時使用。



警告
caution

1. 請使用能負載機器額定功率的電源
2. 保持設備的通風，遠離易燃物品
3. 將設備放置在水平平坦的表面
4. 在儲存運輸和運行環境中，請注意防水



Remove all protective materials.
移除所有包裝物質



Feature commentary 控制面板詳解

2

-  電源開關
-  倒計時開始
-  進入設置
-  數值增加
-  數值減少
-  加熱狀態

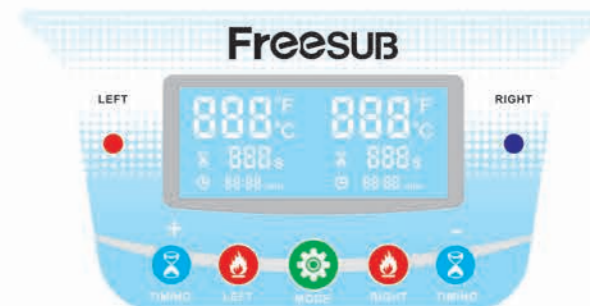

POWER	LEFT RIGHT	MODE	TIMING	PLUS	MINUS
Press power button at back of the machine, it will start to heat and air inflating by itself after five seconds.	Press left button, start heating Press right button, start heating.	State 1: Short press to set temperature. Press again to set time. Press again to quit. State 2: Press 5 seconds to set pre-heating temperature to avoid mug pad air burning.	State 1: Press TIMING one time to start. State 2: Press 4 seconds to reset. State 3: Can be used as "+" and "-" under stand-by state.	State 1: You can increase value under setting state. State 2: Press 2 seconds, hear one beep, you can press "-" to set processing capacity.	State 1: You can decrease value under setting state. State 2: Press 5 seconds, hear one beep, press "+" to set processing capacity.

POWER	LEFT RIGHT	MODE	TIMING	PLUS	MINUS
打開機器後面船形電源開關，機器通電，5秒後自動開始加熱并衝氣。	打開左邊加熱開始 打開右邊加熱開始	狀態1： 短按進入溫度設置 再按進入時間設置 再按退出 狀態2： 長按5秒進入預熱溫度設置，預防烤杯墊空燒。	狀態1： 按一下倒計時開始 狀態2： 長按4秒計時復位 狀態3： 在待機狀態下可當+ -號使用	狀態1： 在設置狀態下可增加數值。 狀態2： 長按2秒後滴一聲響後再按-鍵，可設置加工數量。	狀態1： 在設置狀態下可減少數值。 狀態2： 長按5秒後滴一聲響後再按+鍵，可設置加工數量。

組合鍵功能解說

1、預熱溫度設置



+5s

長按5秒時入預熱溫度設置，出廠初始溫度為100度。

2、加工量設置



先長按 "+" 2秒聽到蜂鳴一聲， "+" 不鬆開，再按下 "-"，蜂鳴一聲。進入計數設置。鬆開按鍵後，按 "+" "-" 調節加工數量。

3、總量統計



先長按 "-" 2秒聽到蜂鳴一聲， "-" 不鬆開，再按下 "+"，蜂鳴一聲。進入從出廠到當前總的數量統計。

Function Commentary of Combination Key

1、pre-heat temperature setting



Press 5 seconds start pre-heat temperature setting. Factory default temperature is 100°C.

2、processing capacity setting



Press "+" for two seconds, hear one beep, keep press. Then press "-", after hear one beep, you can set. Release button, press "+" and "-" to set amount.

3、gross statistics



Press "-" for two seconds, hear one beep, keep press. Then press "+", after hear one beep, you can see the gross statistics from factory default to now.

°F ↔ °C

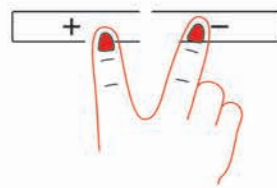

注意：同時按住（+/-）鍵可快速實現攝氏度和華氏度之間的轉換。

Attention: Press (+/-) at the same time, you can switch between °F & °C.

Accessory Name Graphic 配件名稱圖解

3

- | | |
|-----------|---------------------------|
| 1、右压力手柄 | 1.right pressure handle |
| 2、右调节螺丝 | 2.right adjusting screw |
| 3、右烤杯垫 | 3.right mug pad |
| 4、电路主板 | 4.circuit board |
| 5、前电路盖板 | 5.front circuit cover |
| 6、镁合金底座 | 6.magnesium alloy base |
| 7、左烤杯垫 | 7.left mug pad |
| 8、左调节螺丝 | 8.left adjusting screw |
| 9、左压力手柄 | 9.left pressure handle |
| 10、烤杯垫接线位 | 10.mug pad terminal block |

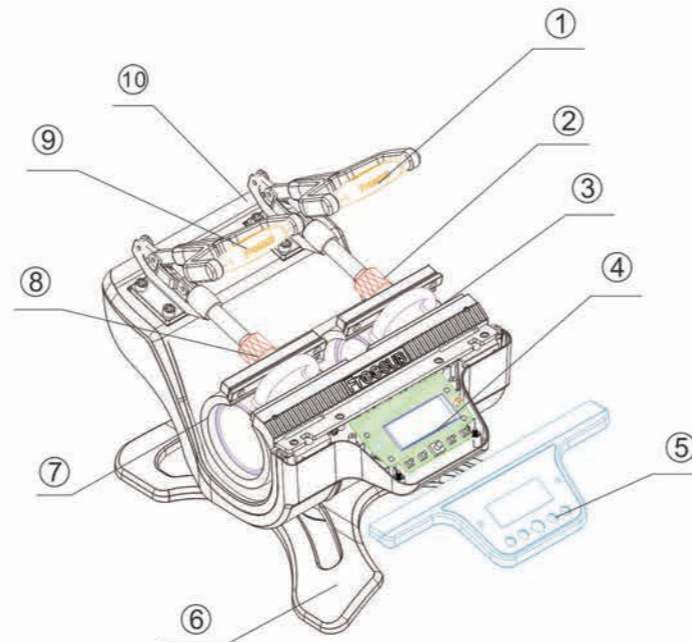

1 connection method 电路板的接线方法

2 power cord colors 电源线的颜色

- | | |
|--|-------------|
| | 1、白色（主进线+） |
| | 2、咖啡色（主进线-） |
| | 3、兰色（左发热垫+） |
| | 4、红色（右发热垫+） |
| | 5、黑色（左发热垫-） |
| | 6、黑色（右发热垫-） |
| | 7、右温度探头 |
| | 8、左温度探头 |

- | |
|------------------------------|
| 1、white |
| 2、coffee |
| 3、blue |
| 4、red |
| 5、black |
| 6、black |
| 7、right temperature detector |
| 8、left temperature detector |

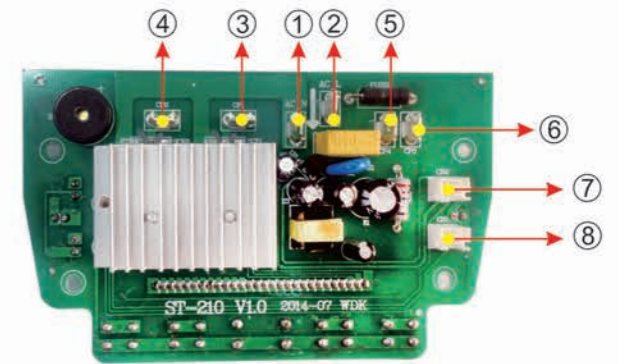

Transfer tips

Question: Transfer paper shows yellow after printing.
Or writings on the picture seems faint.
Answer: Lower temperature and reduce the heating time.
Question: Paper still keep white after printing, and picture color on products don't show good. Sometimes get white stain
Answer: Higher temperature and increase time.
Question: Effect is not good in some condition.
Answer: The temperature and time have to be changed accordingly due to different paper, products, machines and weather condition.

轉印技巧：

轉印時如紙發黃、圖片黑色文字發虛時，應降低溫度及減少時間，如：轉印紙還是白色、圖片色彩不鮮艷，有白色斑點或部分沒有轉印上去，請加高溫度或延長時間。全黑圖片應加長轉印時間，因產品種類、圖片色彩、紙張不同、機器溫差、天氣溫差等不同原因，轉印時溫度及時間會有一些微調。

Answers to questions 常見問題解答

4

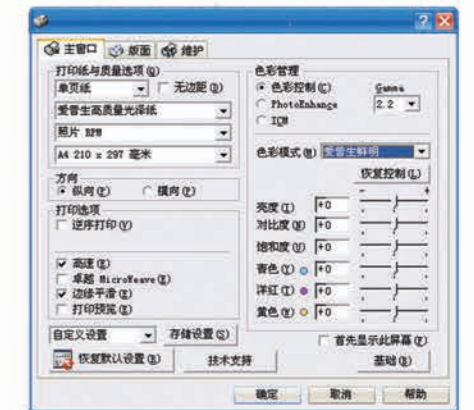
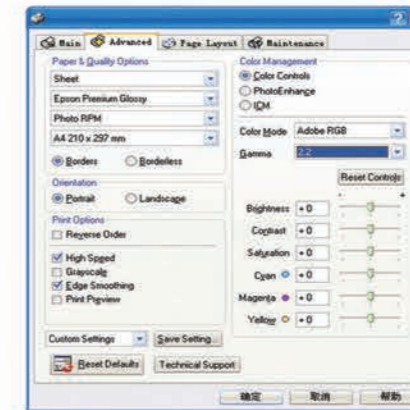

保修卡 WARRANTY CARD

用户姓名 The name:	
联系方式 Contact:	
购买日期 Date:	
经销商 Dealer:	

BestSub®

Product certification
產品合格證

檢驗員
Examiner: _____

日期
Date: _____